

# Agilent Solid State Switches

## Application Note

### Selecting the right switch technology for your application

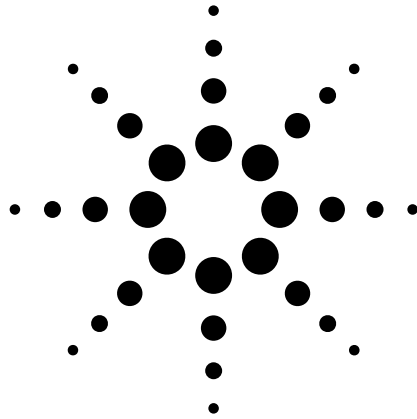

## Abstract

Selecting the right switch technology (in terms of RF performance, reliability, switching time, power handling, etc.) to accessorize and/or complement your system set-up requires an investment of time and resources. This application note will not only enhance your core knowledge of the various switch technologies, but will also provide a selection of products currently offered by Agilent to serve as a platform of comparisons for the technologies explained. The two mainstream switch technologies in use today, namely solid state and electro-mechanical (EM), will be discussed. The primary focus will be on the theory of operation, coupled with detailed explanation on some of the typical performance details.

## Introduction

RF and microwave switches are used extensively in microwave systems for signal routing between instruments and devices under test (DUT). Incorporating a switch into a switch matrix system lets you route signals from multiple instruments to single or multiple DUTs. This enables multiple tests to be performed with the same setup, eliminating the need for frequent connect and disconnects. The entire testing process can then be automated increasing throughput in a high volume production environment.

## Types of Switches

Before selecting a switch, it is important to understand the fundamental differences between switches. There are two major types of connectorized RF and microwave switch modules:

- a) Electro-mechanical switches. They rely on mechanical contacts as their switching mechanism.
- b) Solid state switches. There are two main types of solid state switches: field-effect transistors (FETs) and PIN diodes. FET switches create a channel (depletion layer) that allows the current to flow from the drain to the source of the FET. The PIN diode consists of a high resistivity intrinsic (I) layer sandwiched between highly doped positively (P) charged material and negatively (N) charged material.

# Solid State Switch Overview

FETs and PIN diodes have long been used for switching applications. A brief overview of their characteristics will be helpful in understanding how switches operate.

## Using FETs for switching

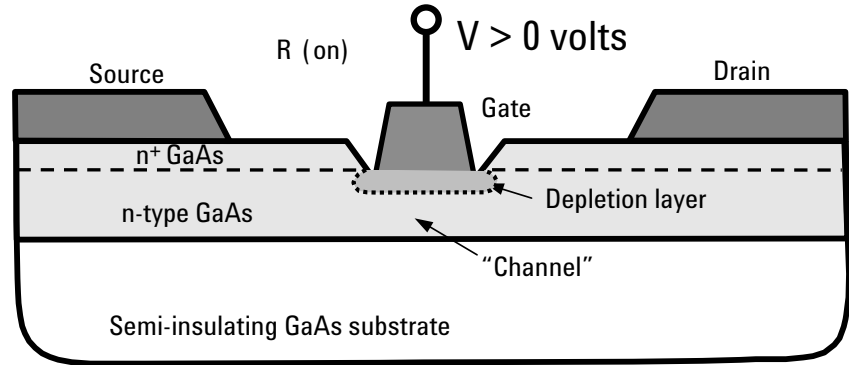

a) Low channel resistance (maximum cross-section)

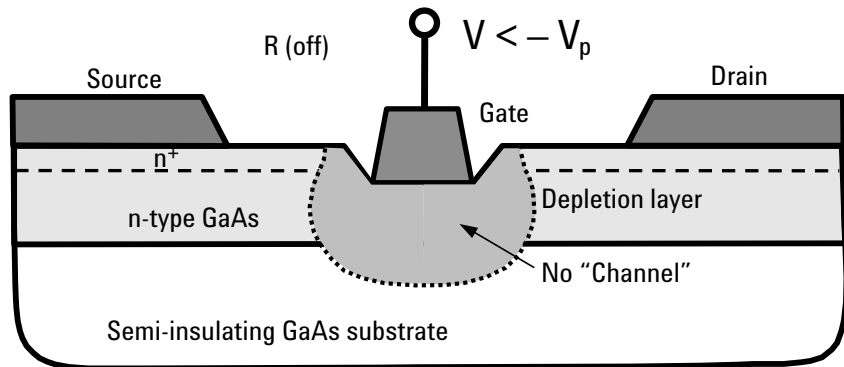

b) High channel resistance (punch-through)

Figure 1. "On" and "Off" states in a field-effect transistor

FET switches are very stable and repeatable due to good control of the drain-to-source resistance ( $R_{DS}$ ). Figure 1(a) shows the low channel resistance ( $R_{DS} = R_{ON}$ ) which allows these switches to operate at low frequencies (down to DC). In the off state, as shown in Figure 1(b), the conduction channel is depleted (pinched off), which causes the FET to exhibit very high resistance ( $R_{OFF}$ ). This mechanism ensures that FETs provide excellent isolation at low frequencies. The isolation of FET degrades at higher frequencies due to the effect of drain-to-source capacitance ( $C_{DS}$ ). Figure 2 shows a GaAs MESFET schematic, with Equation 1 showing the drain-to-source impedance as equal to  $320 \Omega$  at 10 GHz. This is equivalent to an isolation of 10.5 dB between the drain and the source. Therefore, FET switches do not have good isolation at high frequencies.

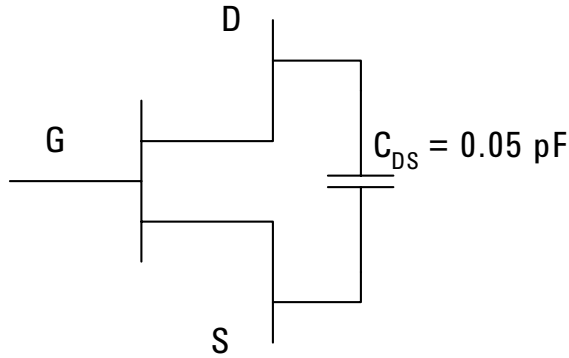
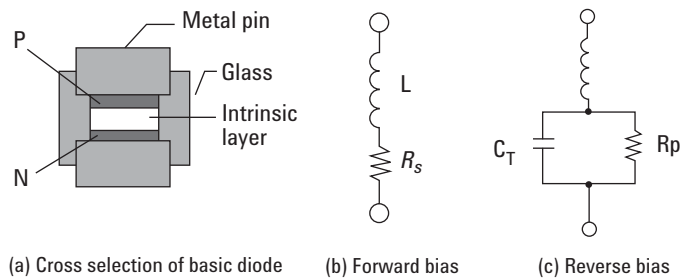

Figure 2. GaAs MESFET schematic

$$C_{DS} = 0.05 \text{ pF}, f = 10 \text{ GHz} \quad \text{Equation 1}$$

$$|X_c| = \left| \frac{1}{j\omega C} \right| = \left| \frac{1}{j2\pi f C} \right| \approx 320 \Omega$$

## Using PIN diodes for switching



**Figure 3. PIN diode equivalent circuits**

PIN diodes are another mainstream switching technology. The PIN diode structure consists of an intrinsic (I) layer with very high resistivity material sandwiched between regions of highly doped positively (P) charged and negatively (N) charged material as shown in Figure 3(a).

When the PIN diode is forward biased, positive charges from the P region and negative charges from the N region are injected into the I-layer increasing its conductivity and lowering its resistance. Figure 3(b) shows the equivalent circuit with the PIN diode forward biased.  $L$  is the parasitic inductance and  $R_s$  is the series resistance, approximately  $1 \Omega$  depending on the biasing applied and the PIN diode structure.

With reverse or zero biasing, the I layer is depleted of charges and the PIN diode exhibits very high resistance ( $R_p$ ) as shown in Figure 3(c).  $C_T$  is the total capacitance of the PIN diode which is the sum of the diode junction capacitance ( $C_{J0}$ ) and the parasitic capacitance ( $C_p$ ). Capacitance limits switch performance at high frequencies in the form of isolation roll-off and increased insertion loss. A low capacitance diode may help improve performance at higher frequencies.

The most important feature of the PIN diode is its basic property as an almost pure resistor at RF and microwave frequencies. Its resistance value varies from  $10 \text{ K}\Omega$  to less than  $1 \Omega$  depending on the amount of current flowing through it. Two key PIN diode characteristics are:

- The lowest operating frequency of PIN diode is given by Equation 2. The PIN diode will behave like a PN diode if it operates below this frequency. The RF signal will be rectified by the diode.

$$f = \frac{1}{2\pi\tau} \quad \text{Equation 2}$$

where  $\tau$  equals the minority carrier life time

- The PIN diode impedance (forward bias) at RF and microwave frequencies depends primarily on DC forward bias, *not* on the RF or microwave signal.

## Hybrid switches

It is clear that both PIN diodes and FETs provide distinctive advantages. However, neither exhibit superior bandwidth and isolation requirements at the same time. So, hybrid switches using FET and PIN diode technology were created to provide wide bandwidth and high RF performance switching.

The theory of operation of hybrid switches is summarized below.  
Hybrid switches use:

- Series FETs to extend the frequency response down to DC. (Series FETs provide excellent low frequency isolation.)
- Shunt PIN diodes at  $\lambda/4$  spacing to provide good isolation performance at the high-end frequencies.

The utilization of series FETs instead of PIN diodes also provides better repeatability performance because the  $R_{DS\ ON}$  is well controlled.

## Switch Selection

It is important to know how to select the right switch for your application. This section provides useful guidelines for this purpose.

Table 1 shows the key performance comparison of electro-mechanical versus solid state switches.

**Table 1. Mechanical and solid state switch performance comparison (typical)**

Switch type	Electro-mechanical	Solid state		
		(FET)	(PIN)	(Hybrid)
Frequency range	from DC	from DC	from MHz	from kHz
Insertion loss	low	high	medium	high
Isolation	good across all frequencies	good at low-end frequencies	good at high-end frequencies	good at high-end frequencies
Return loss	good	good	good	good
Repeatability	good	excellent	excellent	excellent
Switching speed	slow	fast	fast	fast
Power handling	high	low	low	low
Operating life	medium	high	high	high
ESD immunity	high	low	medium	low
Sensitive to	vibration	RF power overstress, temperature	RF power overstress, temperature	RF power overstress, temperature

Table 2 shows the performance comparison of Agilent electro-mechanical and solid state switches. The key parameters and typical performances will be discussed in the following sections.

**Table 2. Mechanical and solid state switch performance comparison (typical)**

Switch type	Electro-mechanical N1810TL	Solid state (hybrid) N9397C	Solid state (PIN) 85331B
Frequency range	DC – 26.5 GHz	300 kHz – 18 GHz	45 MHz – 50 GHz
Insertion loss	< 0.6 dB	< 6 dB	< 15.5 dB
Isolation	120 dB @ 26.5 GHz	100 dB @ 6 GHz	100 dB @ 0.5 GHz
Switching speed	10 – 50 ms	< 250 ns	< 1 us
Power handling	30 W @ 4 GHz (cold switching)	0.5 W	0.5 W
Operating life	> 5 million cycles	infinite	infinite

## Insertion loss

Insertion loss plays an important role in many applications. In receiver applications, the effective sensitivity of the system is reduced by the amount of insertion loss. In system applications where the additional power needed to compensate for the loss (e.g. using amplifiers) may not be readily available, possibly due to cost or space constraints, low insertion loss will be the crucial element. Different switch technologies exhibit different insertion loss performance. Electro-mechanical switches, which have the lowest loss (up to 26.5 GHz), are suitable for these types of applications. Refer to Figure 4.

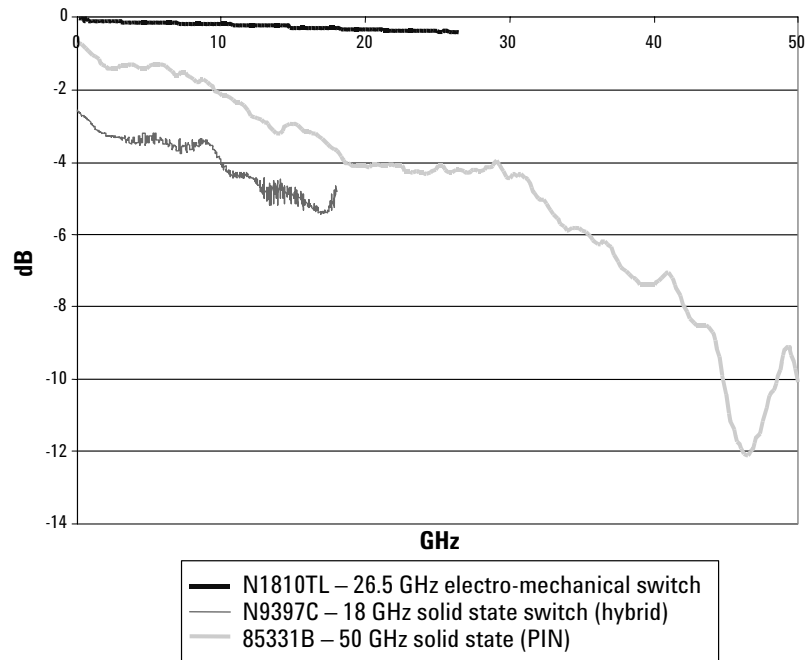

Figure 4. Electro-mechanical versus solid state switch insertion loss (typical)



## Isolation

High isolation in switches is crucial in most measurement applications. Good isolation prevents stray signals from leaking into the desired signal path. In other words, an unwanted signal needs to be attenuated before it has an opportunity to reach a particular test port. High isolation is especially crucial in measurement systems where signals are consistently being routed to and from a variety of sources and receivers through various switch test ports. If these stray signals are allowed to filter through, measurement integrity is severely compromised. Figure 5 shows that the Agilent N1810TL electro-mechanical switch provides the best isolation performance (typically less than 120 dB from DC to 26.5 GHz) compared to the solid state switches. The 85331B 50 GHz solid state (PIN) switch provides excellent isolation performance from 4 to 50 GHz, whereas the N9397C 18 GHz solid state (hybrid) switch offers typically > 100 dB of isolation up to 6 GHz.

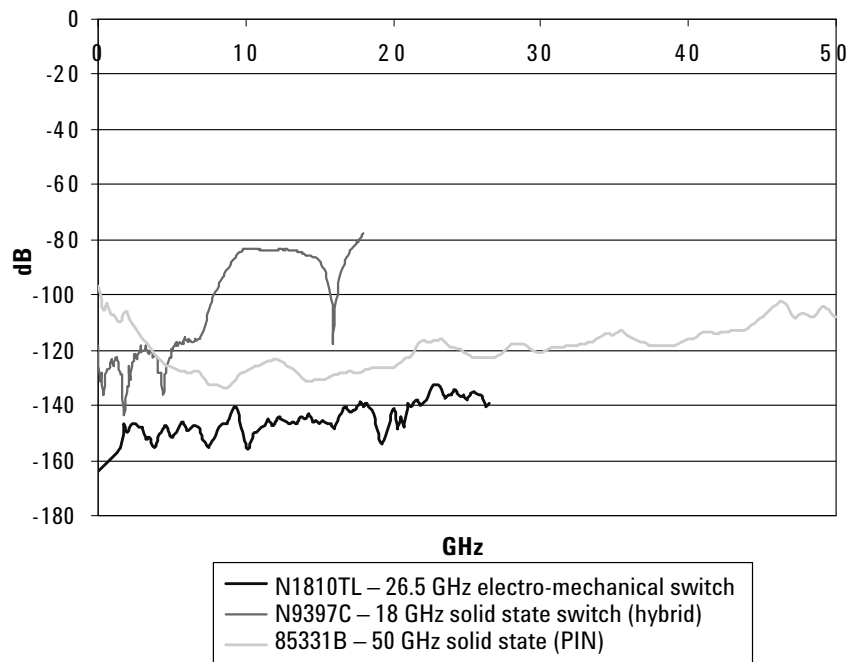

Figure 5. Electro-mechanical versus solid state switch isolation (typical)

## Switching speed

The measurement of switching speed is based on 10% to 90% RF, using a high speed generator and an oscilloscope. Switching speed has been and will continue to be one of the main strengths of GaAs FET switches. With ideal driver circuits, GaAs FET IC switches have been shown to switch within < 1 ns (die level). Looking into the future, the emergence of InGaAs material is expected to push the switching speed well into the sub-nanosecond region.

Fast switching speed is important in ATE industries where product (testing) through-put is of paramount importance. It is especially important in applications that require the stacking of multiple switches in series. Another new technology usage is in the automotive industry, namely for Adaptive Cruise Control (ACC) and Collision Avoidance Systems (CAS), where high-frequency transmitting and receiving switching rates need to be thoroughly analyzed.

As can be seen from *Table 2* on page 7, the switching time for N9397C 18 GHz solid state (hybrid) switch is the fastest, followed by the 85331B 50 GHz solid state (PIN) switch and N1810TL 26.5 GHz electro-mechanical switch, respectively.

## Operating life

The switch operating life is specified as the minimum number of cycles (the number of times it switches from one position to another and back) before the switch starts to fail (i.e. where it no longer performs up to the minimum specifications). Switch operating life is crucial when the switch is being integrated into test and measurement instruments or systems which require thousands of switching cycles for a single round of measurements. In this context, solid state switches would be the preferred choice.

## Other key parameters

Besides the four key parameters discussed above, there are a few other aspects that need to be considered in the switch selection process. Electro-mechanical switches are sensitive to vibration due to a switching mechanism that relies solely on mechanical contacts. On the other hand, solid state switches are sensitive to RF overstress and temperature due to the limitation of the solid-state devices. In addition, solid state FET switch ICs are very sensitive to ESD, in comparison to their electro-mechanical counterparts.

## **Conclusion**

This application note illustrated the multiple aspects of the various switch technologies and their respective usage. The selection guide and switch overview sections have been specially tailored to assist you in selecting the right Agilent switch to optimize test performance and throughput for your applications.

# Web Resource

[www.agilent.com/find/mta](http://www.agilent.com/find/mta)

## Agilent Email Updates

[www.agilent.com/find/emailupdates](http://www.agilent.com/find/emailupdates)

Get the latest information on the products and applications you select.

## Agilent Direct

[www.agilent.com/find/agilentdirect](http://www.agilent.com/find/agilentdirect)

Quickly choose and use your test equipment solutions with confidence.

## Agilent Open

[www.agilent.com/find/open](http://www.agilent.com/find/open)

Agilent Open simplifies the process of connecting and programming test systems to help engineers design, validate and manufacture electronic products. Agilent offers open connectivity for a broad range of system-ready instruments, open industry software, PC-standard I/O and global support, which are combined to more easily integrate test system development.

# www.agilent.com

## Agilent Technologies' Test and Measurement Support, Services, and Assistance

Agilent Technologies aims to maximize the value you receive, while minimizing your risk and problems. We strive to ensure that you get the test and measurement capabilities you paid for and obtain the support you need. Our extensive support resources and services can help you choose the right Agilent products for your applications and apply them successfully. Every instrument and system we sell has a global warranty. Two concepts underlie Agilent's overall support policy: "Our Promise" and "Your Advantage."

### Our Promise

Our Promise means your Agilent test and measurement equipment will meet its advertised performance and functionality. When you are choosing new equipment, we will help you with product information, including realistic performance specifications and practical recommendations from experienced test engineers. When you receive your new Agilent equipment, we can help verify that it works properly and help with initial product operation.

### Your Advantage

Your Advantage means that Agilent offers a wide range of additional expert test and measurement services, which you can purchase according to your unique technical and business needs. Solve problems efficiently and gain a competitive edge by contracting with us for calibration, extra-cost upgrades, out-of-warranty repairs, and onsite education and training, as well as design, system integration, project management, and other professional engineering services. Experienced Agilent engineers and technicians worldwide can help you maximize your productivity, optimize the return on investment of your Agilent instruments and systems, and obtain dependable measurement accuracy for the life of those products.

### United States:

(tel) 800 829 4444

(fax) 800 829 4433

### Canada:

(tel) 877 894 4414

(fax) 800 746 4866

### China:

(tel) 800 810 0189

(fax) 800 820 2816

### Europe:

(tel) 31 20 547 2111

### Japan:

(tel) (81) 426 56 7832

(fax) (81) 426 56 7840

### Korea:

(tel) (080) 769 0800

(fax) (080) 769 0900

### Latin America:

(tel) (305) 269 7500

### Taiwan:

(tel) 0800 047 866

(fax) 0800 286 331

### Other Asia Pacific

### Countries:

(tel) (65) 6375 8100

(fax) (65) 6755 0042

Email: [tm\\_ap@agilent.com](mailto:tm_ap@agilent.com)

Contacts revised: 09/26/05

For more information on Agilent Technologies' products, applications or services, please contact your local Agilent office. The complete list is available at:

[www.agilent.com/find/contactus](http://www.agilent.com/find/contactus)

Product specifications and descriptions in this document subject to change without notice.

© Agilent Technologies, Inc. 2006

Printed in USA, May 30, 2006

5989-5189EN



Agilent Technologies